

*Since 1968*

**COMMAX**  
SmartHome & Security

# User Manual

GATE VIEW PLUS MONITOR (CAV-1020IG+)



[www.commax.com](http://www.commax.com)

**COMMAX Co.,Ltd.**



- Thank you for purchasing COMMAX products.
- Please carefully read this User's Guide (in particular, precautions for safety) before using a product and follow instructions to use a product exactly.
- The company is not responsible for any safety accidents caused by abnormal operation of the product.



# Table of contents

1. Warnings and caution .....	3
2. Part name and Function .....	5
3. Usage instruction .....	6
4. User Setting .....	9
5. System Setting .....	11
6. How to use lobby phone .....	14
7. Installation method .....	15
8. Component .....	15
9. Wiring method .....	16
10. Instructions for use .....	18
11. Miscellaneous .....	18
12. Specification .....	18



# 1. Warnings and caution

Please follow the things described below in order to prevent any danger or property damage.

	<b>Warning</b>	It may cause a serious damage or injury if violated.
	<b>Caution</b>	It may cause a minor damage or injury if violated.

	Prohibition.
	No disassembly
	No touch
	Must follow strictly.
	Shows plugging out the power cord without an exception
	Shows the warning and caution for an electric shock.
	Shows the warning and caution for a fire.

## Warning

Power & Installation

<p>Please don't use several products at the same time on one power socket.</p> <ul style="list-style-type: none"> <li>It may cause a fire due to an abnormal overheating.</li> </ul> <p> </p> <p>Prohibition Fire</p>	<p>Please don't bend the power cable excessively or it may cause an electric shock.</p> <ul style="list-style-type: none"> <li>fire when using a damaged power cable.</li> </ul> <p> </p> <p>Prohibition Electric shock Fire</p>	<p>Please don't handle the power cable with a wet hand.</p> <ul style="list-style-type: none"> <li>It may cause an electric shock.</li> </ul> <p> </p> <p>Prohibition Fire</p>	<p>Please plug out the power cable from the socket when not using it for a long period of time.</p> <ul style="list-style-type: none"> <li>It may shorten the product lifespan or cause a fire.</li> </ul> <p> </p> <p>Request Fire</p>
<p>Please don't install the product in the place where there is much oil, smoke or humidity.</p> <ul style="list-style-type: none"> <li>It may cause an electric shock or fire.</li> </ul> <p> </p> <p>Prohibition Electric shock Fire</p>	<p>Please don't install the product with the lightning and thunder.</p> <ul style="list-style-type: none"> <li>It may cause an electric shock or fire.</li> </ul> <p> </p> <p>Prohibition Electric shock Fire</p>	<p>Please don't use and connect this product with other products with different rated voltage.</p> <ul style="list-style-type: none"> <li>It may cause a disorder or fire.</li> </ul> <p> </p> <p>Prohibition Fire</p>	<p>When installing the product that generates heat, please install the product away from the wall (10cm) for the ventilation.</p> <ul style="list-style-type: none"> <li>It may cause a fire due to the increased internal temperature.</li> </ul> <p> </p> <p>Prohibition Fire</p>

## ⚠ Warning

### Cleaning & Use

Please don't disassemble, repair or rebuild this product arbitrarily (please contact the service center if a repair is needed).

- It may cause an electric shock or fire.

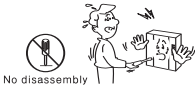

If an abnormal sound, burning smell or smoke is coming out of the product, please plug out the power cable and contact a service center.

- It may cause an electric shock or fire.



Please don't insert any metallic or burnable materials into the ventilation hole.

- It may cause an electric shock or fire.



Please use only the designated batteries for the products of using DC power.

- It may cause an electric shock or fire.



## ⚠ Caution

### Power & Installation

Please plug the power cable firmly into the inner end

- It may cause a fire.

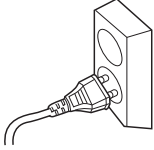

Please hold the plug tightly when unplugging the power cable (a part of the copper wire may be disconnected if the grabbing is only made on the cord when pulling out the cable).

- It may cause an electric shock or fire



When connecting the power cables after cutting the cable, please install the product with power off

- It may cause an electric shock or fire



When installing the product, please fix it firmly while using the wall-mounting unit and screws.

- It may cause an injury from the falling object.

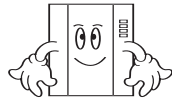

Please be careful when using an AC circuit breaker since there is a possibility of an electric shock.

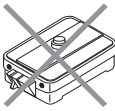

Please check the use voltage and current for the DC-only products and use the appropriate rectifier.

- It may cause a fire.



Please avoid direct rays of the sun or heating devices at a time of installation.

- It may cause a fire.



Please don't install the product on an unstable place or small support board.

- It may cause an injury if it falls down while in use.



### Cleaning & Use

When cleaning the product, please rub it with a soft and dry cloth after plugging out the power cable. (Please don't use any chemical products such as wax, benzene, alcohol or cleanser.)



Please don't drop the product on the ground and don't apply a shock.

- It may cause a failure.

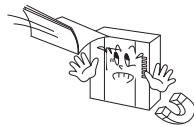

Please use the designated connection cable within the maximum calling distance designated for the product

- It may reduce the product performance.





## 2. Part name and Function

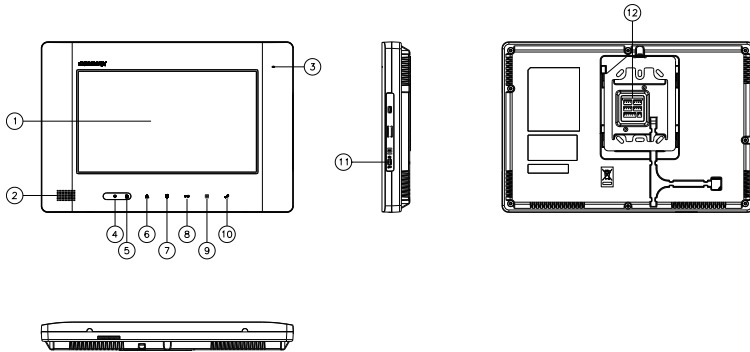

No	Description	No	Description	No	Description
1	LCD monitor	5	Away button	9	MENU button
2	Speaker	6	Monitoring button	10	Talk button
3	Microphone	7	Guard call/ paging elevator button	11	On/Off Switch
4	Power indicator LED	8	Door release button	12	External wiring connection socket

- ① LCD monitor : menu, visitor display
- ② speaker
- ③ Microphone
- ④ Power indicator LED
- ⑤ Away button: For Away set/clear
- ⑥ Monitoring button: Lobby monitoring
- ⑦ Guard call/ paging elevator button : Guard call/ paging elevator
- ⑧ Door release button : For opening door
- ⑨ MENU button : For Menu start/exit
- ⑩ Talk button : For call start/exit
- ⑪ On/Off Switch
- ⑫ External wiring connection socket: For Lobby, Guard, Alert and Security sensor connection

※ This product is compatible with Lobby, Guard unit for Gateview System



## 3. Usage instruction

### 3-1. Call from the individual entrance

- ① When the visitor presses the call button, an electronic chime sound rings and the visitor's image appears on the monitor.
- ② Conversation with the individual entrance will begin when you presses the call button. To release the door lock, press the door release button.  
(Only in case of using the screen turned on, open& shut can be used)
- ③ When you receive the call from Lobby or Guard Station during the conversation with the individual entrance, the electronic chime sound rings. Then, press the talk button to end the call with a guard station and press the call button again to begin the conversation with a visitor .
- ④ Screen will be turned off after 60 sec automatically, press the monitoring button to check again.
- ⑤ When press the talk button after the end of talking with a visitor, screen is turned off and all is done.

### 3-2. Call from the Lobby

- ① Visitor's image will be shown on the monitor with emitting chime sound when a visitor presses the call button
- ② Press the talk button by watching visitor and talk with a visitor.  
(Screen will be returned off after 60 sec automatically from the beginning of conversation)
- ③ When you receive the call from Lobby or Guard Station during the conversation with the individual entrance, the electronic chime sound rings. Then, press the monitoring button from the video phone to finish the conversation with lobby and have a conversation with visitor.
- ④ When you press the door release button in the middle of conversation, the lobby gate will be opened with switchgear sound and the conversation will be finished.

### 3-3. Conversation with guard

#### (1) Call from the guard

- ① The sound of call will be emitted when it has a call from guard.
- ② Press the talk button to begin the conversation
- ③ While talking over the phone with the guard station, lower call sound of monitoring will be emitted.  
Then, press the monitoring button from the video phone to finish the conversation with lobby and have a conversation with visitor

#### (2) Calling the guard station

- ① Press the "Talk" button and "Guard call" button in sequence.
- ② Conversation will begin when a guard station responds

### 3-4. Monitoring

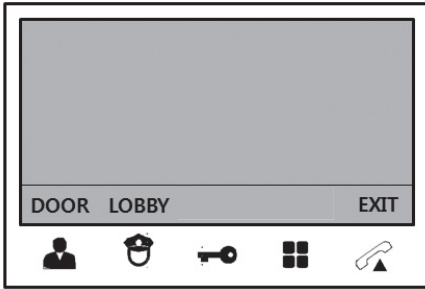

When you receive initial call , your device automatically searches for the door camera and displays OSD accordingly

Display with Door camera

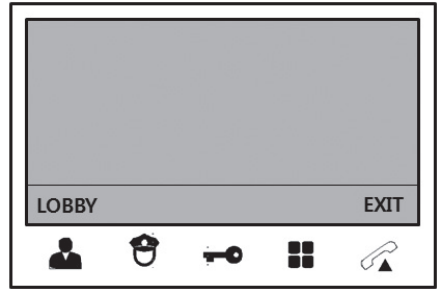

Display with no Door camera



By pressing monitor button, display above appears. If you press button of your desired space (monitoring[  ], guard[  ]), you can monitor according space.

(Door, Lobby,)

- Monitoring (DOOR/LOBBY)function time is 30secs
- You can talk by pressing call button while monitoring(DOOR/LOBBY)
- You can monitor only certain lobby with pre-set ID

### 3-5. Page the elevator

- ① If the elevator pager(CCU-310EV) is connected with monitor, you can use this function.
- ② When you press the guard button while in standby or talking status, The menu is displayed as shown in the picture. (However, the 'GUARD' menu is not displayed when talking with the lobby or guard )
- ③ For paging elevator, press the ELV(corresponding button) while the menu is displayed.
- ④ When you page the elevator, "Elevator CALL" message will be displayed at the top of screen.
- ⑤ If you don't page the elevator, press the EXIT(Talk button).

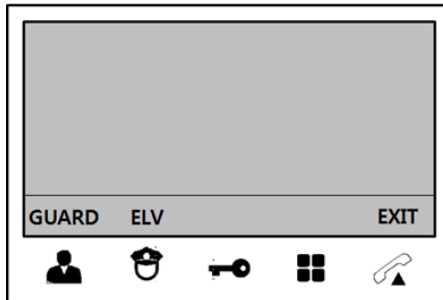

### 3-6. Away and security function

Away and security function enabled by connecting to Security 1(magnetic sensor) and Security 2(PIR sensor)

#### (1) How to set Away set

- ① When you press the 'away' button in standby mode, the "beep" sound occurs and the whole front LEDs blink and Away mode is set
- ② In the away mode, after away set time finishes, the household unit detects security sensor and changes into security mode. The entire front LED stops blinking and remains turned on
- ③ After setting away mode, you should go out within set time.  
(AWAY set time: It is initially set for 60 sec and you can change it from 0 to 90 sec by pressing setting button.)
- ④ After away mode is set, if device detects something abnormal ( external incursion ), the entire front LEDs Immediately flash and the security ring tone will be generated at the household unit and guard unit

#### (2) How to turn off the away set

After return, by pressing 'away button' once, the entire front LED stops blinking and away mode is turned off with 'beep' sound. The device delivers the away mode off message to guard station. It must be turned off within the away mode off time.

(When released from factory, away mode off time is initially set for 0sec. You can change it from 0 to 90 sec by pressing setting button.)

※ Notice: If you don't turn the away mode off, the device will consider you as an intruder and alert tone will ring

#### (3) How to turn off the security bell

When the security bell rings, after checking whether it is real or not, by pressing 'away' button once, you can turn off away mode and can return to initial state with LED blinking and alert tone stopped.  
(When the security bell rings , the release / return is only possible when the sensor is in the normal state, that is, in case of crime security 1, in the state where the contact of the magnetic sensor is made, in case of crime security 2, only when the motion detecting sensor does not detect any movement or intruder.)

### 3-7. Bypass call function [used with away mode]

- When household sets away mode, visitor at lobby or door camera is automatically connected to guard station.  
(In this case, volume of the call can be lower as it is bypassing another route.)

### 3-8. ALARM1( fire ) function



- (1) When alert1 sensor detects fire, alarm tone rings (Fire engine sound) at guard station and monitor
- (2) After checking alert situation is terminated, press away button twice.  
(One time: release/ two times: return), after return, front LED blinking and security 2 alert tone stops.)



### 3-9. ALARM2(Gas) function



- (1) When sensor 2 detects gas release, security2 (Hospital alert tone) alert tone occurs at monitor and guard station device
- (2) After checking alert situation is terminated, press away button twice.  
(One time: release/ two times: return), after return, front LED blinking and security 2 alert tone stops

### 3-10. Approximate alert function

- ① In emergency situation, alert tone is generated and this is delivered to guard station
- ② The message notification is delivered until household turns off the security mode
- ③ After notification, devices changes in to stand-by mode
  - Stand-by mode: pre-mode for ring tone alert. When you receive calls from exterior, device sends alert tone rings to external devices. (lobby, etc.)

### 3-11. Interlocking with Digital Door Lock

This product can be interlocked with Digital Door Lock via RF module and please refer to connection diagram.



## 4. User Setting

After Menu screen appears, you can change setting with below 4 buttons

Menu start and finish : [  ] (Menu button -'[  ]')

SELECT : [  ] (Guard button -'[  ]')

Move upward /move right : [  ] (Door release button -'▲' / '▶')

Move downward /move left : [  ] ( Monitor button -'▼' / '◀')

After pressing MENU button in Video call or monitoring mode, you can change settings for DOOR(LOBBY), VIDEO SET(BRIGHTNESS / CONTRAST/ COLOR), UTILITY (ADDITIONAL FUNCTION) and INFORMATION (product information)

### 4-1, Display setting

DOOR(LOBBY) VIDEO SET (BRIGHTNESS / CONTRAST/ COLOR control function).

After moving to menu with MENU button, press SELECT button to move to the menu below.  
(you can control LOBBY VIDEO SET while you are talking with lobby.)

- (1) BRIGHTNESS : control BRIGHTNESS
- (2) CONTRAST : control CONTRAST
- (3) COLOR : control COLOR

You can control from 0 to 20 level. Initial level is set for level 10

※ how to set

After moving to menu with your desired MENU from 'DOOR VIDEO SET', press SELECT button to move to the menu below  
(you can control 'LOBBY VIDEO SET' while you are talking with lobby.)

(4)RESET: reset display setting

※ how to set

After moving to RESET from DOOR VIDEO SET, press SELECT button for RESET.  
Select YES with move button.  
Complete your setting by pressing SELECT button

※ Notice :Display control and reset function adjusts each video(DOOR/LOBBY) collectively

(5)EXIT: Return to EXIT of initial menu

#### 4-2. UTILITY (additional function)

After moving to MENU with MENU button, press SELECT button to move to below screen

(1) SPEAKER VOLUME: control call volume

There are 3 levels of volume control options and default is level 2

※ how to set

After moving to SPEAKER VOLUME from UTILITY, press SELECT button for SPEAKER VOLUME.  
Select your desired setting.  
Complete your setting by pressing SELECT button

(2) CHIME-BELL VOLUME : control ringing tone

You can control from 0(MUTE) to 3 level. Initial level is set for level 2.

※ how to set

After moving to CHIME-BELL VOLUME from UTILITY, press SELECT button for CHIME-BELL VOLUME.  
Select your desired setting.  
Complete your setting by pressing SELECT button.

(3)EXIT: Return to EXIT of initial menu

#### 4-3. INFORMATION (product information.)

After entering to menu by pressing menu button, you can move to INFORMATION and check product information

(1) MODEL : Shows product name

(2) VERSION : Shows program version

(3) HOME ID : Shows current building No. / Household No

(4) TOUCH : Shows touch program version

(5) VIDEO : Shows current camera output standard. (NTSC / PAL)

(6) SOURCE : This indicates location of current video (Household door unit & Lobby entrance)

#### 4-4. EXIT

Exit from menu



## 5. System Setting

You can set HOME SET(Household information setting) and AWAY SET(Go Out setting), SENSOR SET(Use of Security 2), INFORMATION(Product information check) after pressing menu button for 3 seconds in stand by mode

### 5-1. HOME SET (Household information entry)

Move to HOME SET from System setting mode and select below

#### (1) HOME ID : Setting Building No. and Household No

※ How to set

- ① Move to HOME ID from HOME SET and select
- ② After selecting the number with ► / ◀, press the SELECT button and fill it in from first. : Default on household no is 8 digit numbers. Blanks are marked with 0.  
(ex : Building no : 101 Household no : 1 (0101 - 0001)  
※ Wrong number can be modified with ◀ button.
- ③ When finish inputting 8-digit number, press the select button to save it.

#### (2) PASSWORD :Setting Household Password

※ How to set

- ① Move to PASSWORD section from HOME SET and select below
- ② Enter numerical numbers by using moving button (Initial building/household No. are set "1234".  
You should change password to use)  
※ Warning : For security reason, do not use repeated No  
※ Numbers such as 0000, 1234, 4321 are prohibited to use for security reason

#### (3) LOBBY ID : Set Lobby entrance ID to monitor

※ How to set

- ① Move to LOBBY ID section from HOME SET and select below
- ② Enter numerical numbers out of 01~39 by using moving button  
(Initial Lobby entrance ID No. is set "01")
- ③ Complete setting by pressing "select" button

EXIT : Go back to system setting

## 5-2. AWAY SET (GO OUT MODE SETTING)

Move to AWAY SET from system setting and select below

### (1) AWAY WAIT-SET :

SET the stand by time till sensor detection of household. It's setting for time of leaving the house after setting AWAY MODE. (Initial stand by time : 60seconds)

#### ※ How to set

- ① Move to AWAY WAIT-SET from AWAY SET
- ② Enter numerical numbers(time) by using moving button

#### ※ Attention :

On AWAY SET, if sensor detects that customer doesn't leave the house in designated time, alarm rings. So, customer must leave before setting time

### (2) AWAY WAIT-CLEAR :

Set the stand by time till alarm rings after sensor detection. It's setting for time till canceling AWAY mode after customer enter the house. (Initial stand by time : 0 seconds)

#### ※ How to Set

- ① Move to AWAY WAIT-SET CLEAR from AWAY SET
- ② Enter numerical numbers(time) by using moving button

#### ※ Attention :

After coming back home, customer must clear AWAY mode in designated time. Unless clearing in time, alarm rings

### (3) EXIT: Go back to system setting

### 5-3. SENSOR SET (Security 2, use setting)

Move to SENSOR SET from system setting mode and select below

BURGLAR2 : Setting Security 2. And initial setting is "ON"

- ON : Use Security 2.function
- OFF : Do Not Use Security 2.function

※ How to Set

- ① Move to BURGLAR2 from SENSOR SET and select below.
- ② Select use(ON/OFF) by using moving button
- ③ Complete the setting by pressing select button

### 5-4. INFORMATION (Product Information)

In MENU mode, move to INFORMATION and check out Product Information

- (1) MODEL : Product Name
- (2) VERSION : Product Version
- (3) HOME ID : Currently set Building No. & Household No.
- (4) TOUCH : Touch program Version

### 5-5. EXIT

Exit from Menu



## 6. How to use lobby phone

### 1) When paging the household

- Enter the household number you want to call.  
ex) household 101 ⇒ 1, 0, 1
- Household number appears on FND
- Press the Call button (E)
- Conversation begins when they answer.

### 2) When paging guard station

- Press the guard button
- 'gUAd' appears on FND
- Press the Call button (E)
- Emit call house along with flickering of 'gUAd'.
- Conversation begins when guard station answers.

### 3) Opening the door with RF card

- Press the Household number
- Press the Key button (K)
- Letters of 'PASS' flicker on the FND.
- Press the 4-digit password.
- Appears '----' on the FND.
- Press the Call button
- Door is open with flickering of 'oPEn' on FND .

#### [Reference for use]

Contact guard station or management station if you don't remember the password

### 4) Opening the door with registered RF card (optional function)

- Put the RF card on the sensor positioned right below of camera lens to open the door. Door will be opened along with a message of 'oPEn' on FND.

#### [Reference for use]

1. If you try to open the door with unregistered RF card, it will be notified to guard station. Please try again after registering it at the guard station or management office.
2. If RF card still doesn't work after proper registering procedure, it is not usable card.

- ① Enter the Household Number.  
ex) unit 101
- ② Press the page button.  
A paging tone will sound.

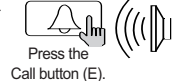

Press the Call button (E).

- ③ Wait for a reply



- ① Press the Guard button.
- ② Press the Page button.  
A paging tone will sound.



Press the Call button (E).

- ③ Wait for a reply



- ① Enter the Household Number.  
ex) To open the door of unit 101
- ② Press the Electronic key button.



- ③ Enter the Household PIN.
- ④ Press the Page button.



Press the Call button (E).





# 7. Installation method

## 1. Installation Method of camera monitor

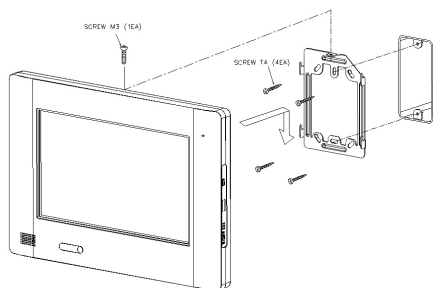

CAV-1020IG+



### Note

- ① Avoid the range of direct sunlight
- ② Recommended height is pertinent from 1450 ~ 1500mm
- ③ Avoid the installation near magnetic activity, humid temperatures and gas



# 8. Component

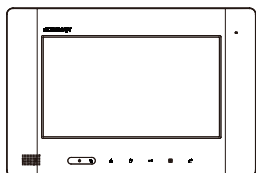

CAV-1020IG+

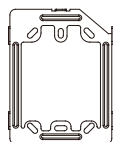

Wall mount bracket

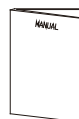

User manual

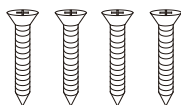

(T)4 X 18mm  
Screws for  
mounting



(M)3 X 6mm  
Screws for main body

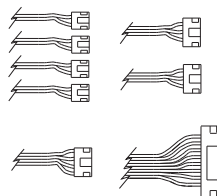

2P(4EA)/3P(2EA)/  
4P(1EA)/ 10P(1EA)  
Connector



BOTTOM ATTACH  
SPONGE(4EA)



# 9. Wiring method

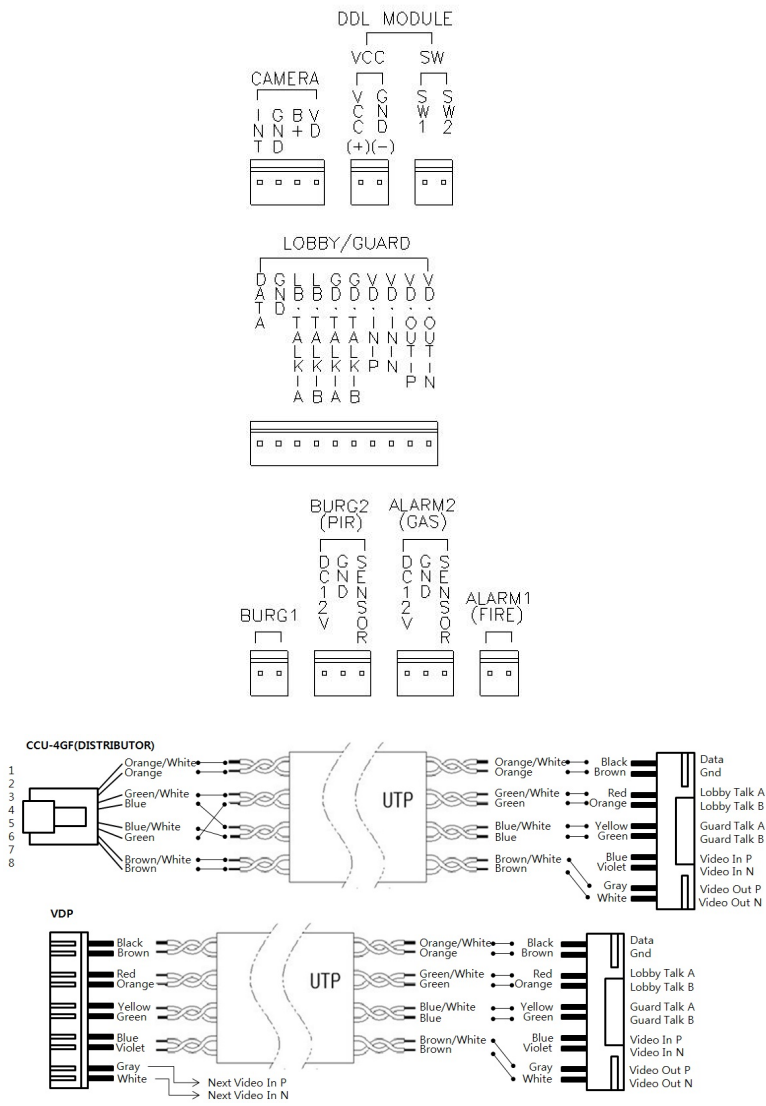

### ※ Cautions for wiring

- 1) If it is to be installed near high voltage line, please use coaxial cable for grounding
- 2) Keep the cable out of the sheath exposure to prevent to be shorted
- 3) Be sure to turn off the monitor before you connect the monitor with cameras.



- 4) Be careful of the polarity of the cable when you connect the monitor with cameras
- 5) Security 1.(Magnetic Sensor)
 

It should be connected with lead switch. If you don't want to use this function, connect 2 wires each other or security sensor 1 & away mode will be deactivated.
- 6) Security 2. (PIR Sensor)
 

Operating voltage is DC 12V. Be sure to check the wire polarity before connecting wires.  
In case of using security 2. sensor, use after 3 minutes from turning on the product for sensor stabilization.
- 7) Lobby Entrance
 

In case of connecting between lobby panel & monitor, please connect them VD/IN(DN), VD/OUT(UP) in order. Wire for transferring video signal between lobby & monitor
- 8) Alarm sensor1 (Fire)
 

Be sure to check the wire polarity before connecting the wires
- 9) Alarm sensor2 (Gas)
 

Operating voltage is DC 12V. Be sure to check the wire polarity before connecting the wires

● What's VD/IN, VD/OUT ?

VD/OUT line from household No.101 to be connected to VD/IN of household No. 201 as described in the drawing

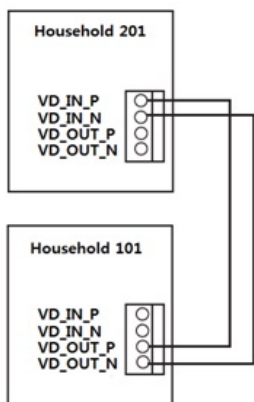

● Household Extension Line

Be careful while wiring since this has polarity. Video cable should be connected VD/IN, VD/OUT

## 10. Instructions for use

1. Turn on the power switch.
2. Please contact your local agent for product maintenance when you have a problem in use of CAV-1020IG+
3. For your safety, power switch with a safety device must be used in your building
4. Unplug before installing or repairing the product
5. Unplug when you connect monitor with door cameras

## 11. Miscellaneous

- Please carefully read this User's Guide before calling service man  
After checking the entire check list, please contact customer service center. We will do our best to make you satisfy with our services

## 12. Specifications

Spec	Model	CAV-1020IG+
Transmission style	CAMERA :4 lines, LOBBY : 8 lines, Security1: 2lines, Security2 : 3lines, Alarm sensor1 : 2lines, Alarm sensor2 : 3lines	
Rated Voltage	100–240V~, 50/60Hz	
Power consumption	MAX : 15W, Stand-by : 3.5W	
Display	10,1 " TFT LED display	
Conversation	HANDS FREE mode(Voice Switch circuit)	
Calling sound	Entrance : Electronic chime, Guard station : Melody	
Talk duration	Standby : 30sec Conversation : 60sec, Guard station : 3min	
Distance	Individual camera : 30m (Ø 0.5 - Line Impedance:3ohm) Common lobby : 300m (UTP), Guard station : 1Km	
Working Temperature	0 ~+40°C (32°F ~ 104°F)	
Dimension	318(W) X 215(H) X 35(D) mm	

# **COMMAX**

**COMMAX Co.,Ltd.**

---

513-11, Sangdaewon-dong, Jungwon-gu, Seongnam-si, Gyeonggi-do, Korea  
Int'l Business Dept. Tel. : +82-31-7393-540~550 Fax. : +82-31-745-2133  
Web site : [www.commax.com](http://www.commax.com)

*Printed In Korea / 2016.10.104*